

## PFL Series Optic Connector

### Product brief introduction

- Bulkhead sealing coupling configuration, connecting 2 or 4-fiber at one time
- Five-key polarization with blind mating and anti-mismatching function
- Ceramic ferrule and sleeve, PC, UPC polishing

### Applications:

- Optical fiber communication networks
- Computer networks

### Performances

Parameter	MM	SM
Insertion Loss (dB)	≤1.0	
Repeatability (dB)	≤1.5	
Vibration	10~55Hz, acceleration 49m/s <sup>2</sup>	
Shock	490m/s <sup>2</sup>	
Durability (cycles)	500	
Thermal shock (°C)	-40~+80	

Note: 1) Insertion loss is only for the plug and cable itself is counted additionally (MM 50/125, [0.8dB/km@1300nm](#); MM 62.5/125, 1dB/km@1300nm)

2) Design per customer's requirements.

### Outline dimensions

[PFL15T2SN-IAF15T2SN two-fiber optic cable connector (used outside the equipment)]

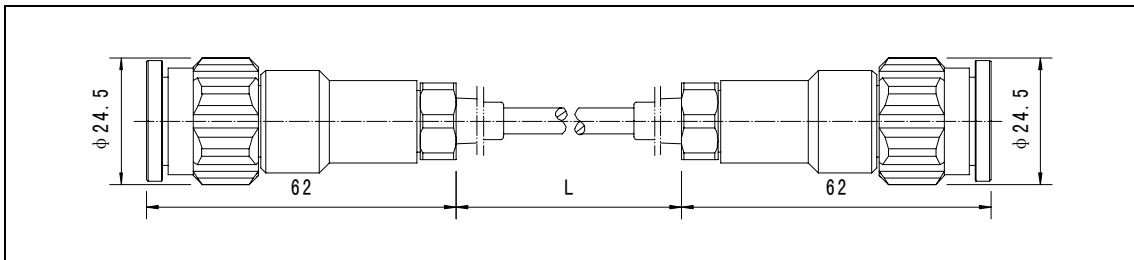

Note: 1) L IS PROVIDED PER USER'S REQUIREMENT.

2) The product mates with PFL15F2PN

[PFL15T2SN two-fiber optic cable connector (used outside the equipment)]

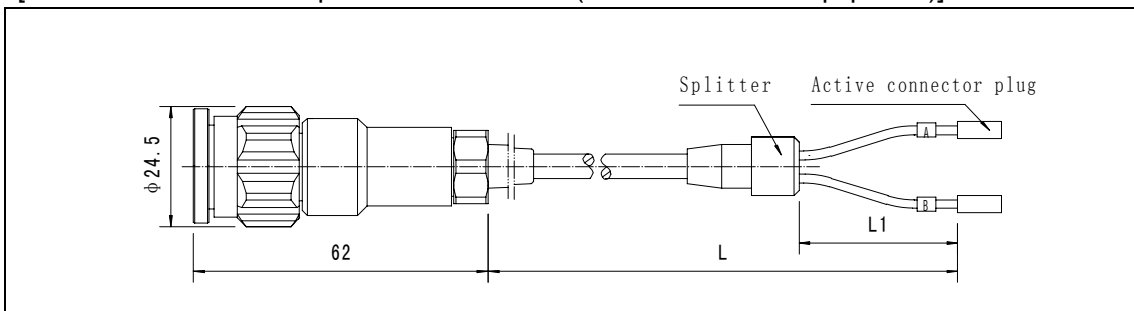

Note: 1) Plug can be anyone in MTRJ, SC, FC, ST, MU and LC;

2) L AND L1 ARE PROVIDED PER USER'S REQUIREMENT.

3) The product mates with PFL15F2PN

[PFL15F2PN two-fiber optic cable connector (used inside the equipment)]

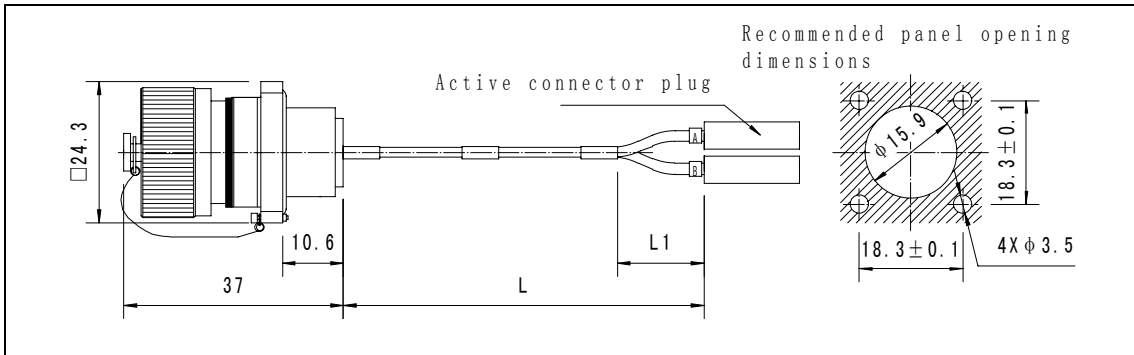

Note: 1) Plug can be anyone in MTRJ, SC, FC, ST, MU and LC;

2) L AND L1 ARE PROVIDED PER USER'S REQUIREMENT.

3) The product mates with PFL15T2SN

[PFL15T4SN-IAF15T4SN 4-fiber optic cable connector (used outside the equipment)]

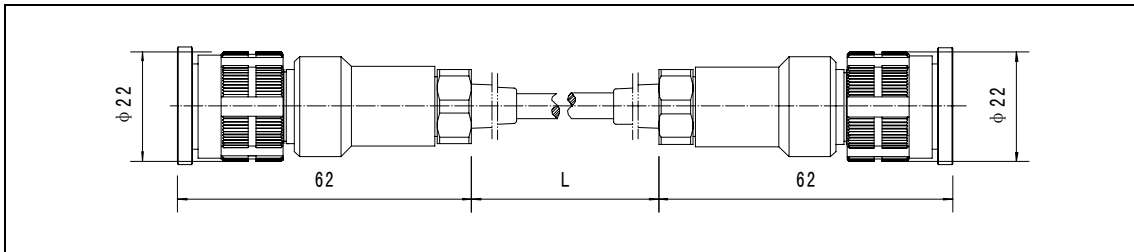

Note: 1) L IS PROVIDED PER USER'S REQUIREMENT.

2) The product mates with PFL15F4PN

[PFL15T4SN 4-fiber optic cable connector (used outside the equipment)]

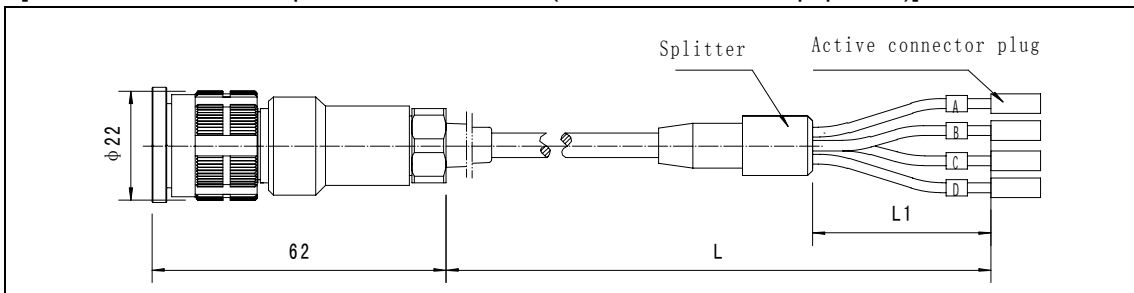

Note: 1) Plug can be anyone in MTRJ, SC, FC, ST, MU and LC;

2) L AND L1 ARE PROVIDED PER USER'S REQUIREMENT.

3) The product mates with PFL15F4PN

[PFL15F4PN 4-fiber optic cable connector (used inside the equipment)]

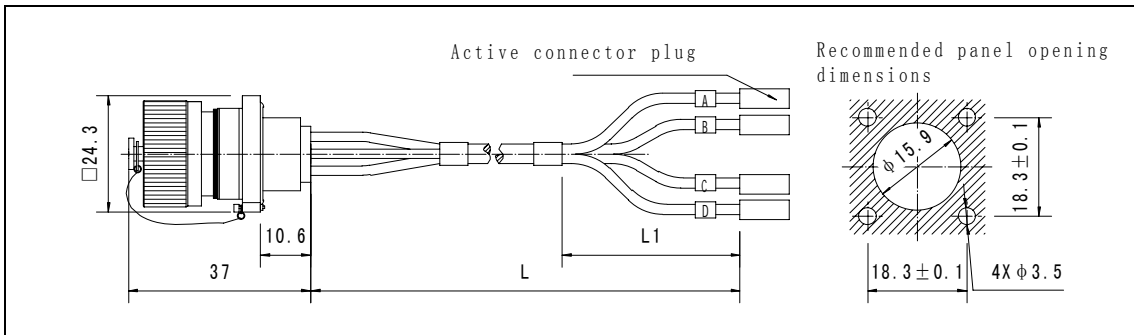

Note: 1) Plug can be anyone in MTRJ, SC, FC, ST, MU and LC;

2) L AND L1 ARE PROVIDED PER USER'S REQUIREMENT.

3) The product mates with PFL15T4SN

[PFL15T4SN01 4-fiber optic cable connector (used outside the equipment)]

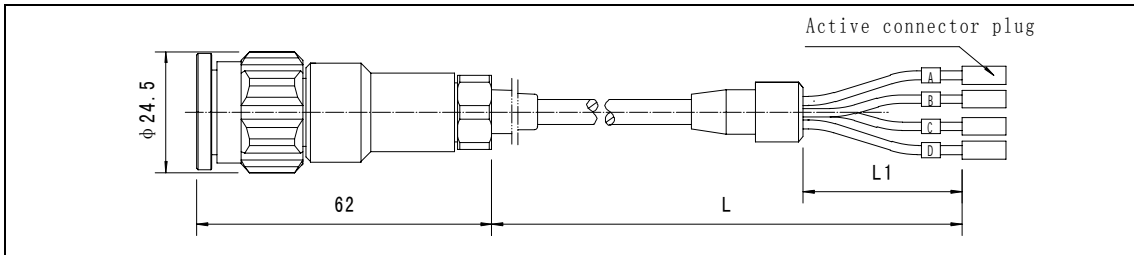

Note: 1) Plug can be anyone in MTRJ, SC, FC, ST, MU and LC;

2) L AND L1 ARE PROVIDED PER USER'S REQUIREMENT.

3) The product mates with PFL15F4PN

[PFL16T2SN-PFL16T2SN 2-fiber optic cable connector (used outside the equipment)]

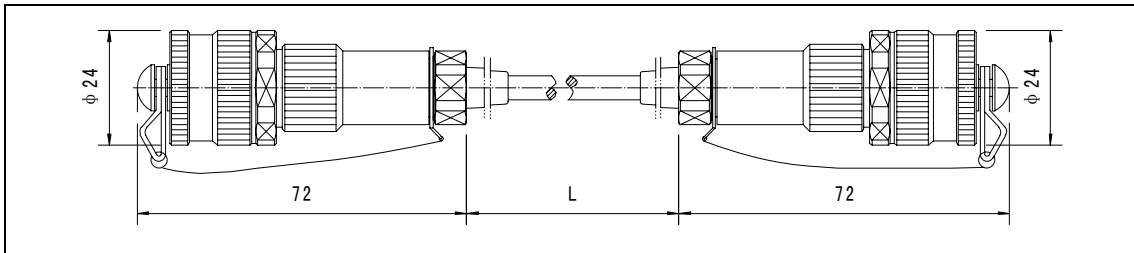

Note: 1) L IS PROVIDED PER USER'S REQUIREMENT.

2) The product mates with PFL16F2PN

[PFL16T2SN 2-fiber optic cable connector (used outside the equipment)]

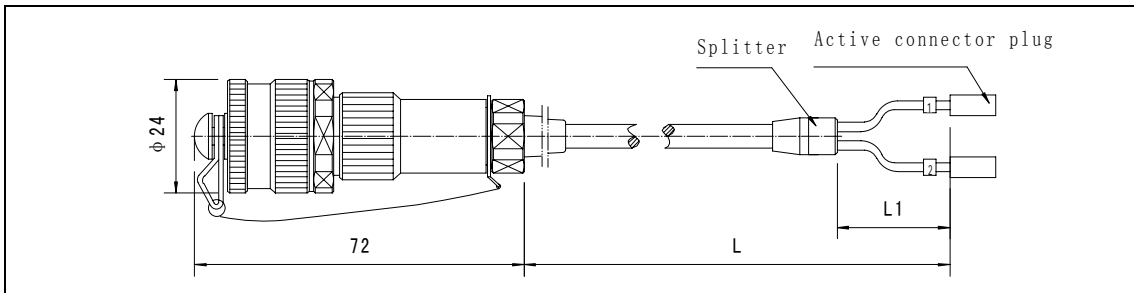

Note: 1) Plug can be anyone in MTRJ, SC, FC, ST, MU and LC;

2) L AND L1 ARE PROVIDED PER USER'S REQUIREMENT.

3) The product mates with PFL16F2PN

[PFL16F2PN 2-fiber optic cable connector (used inside the equipment)]

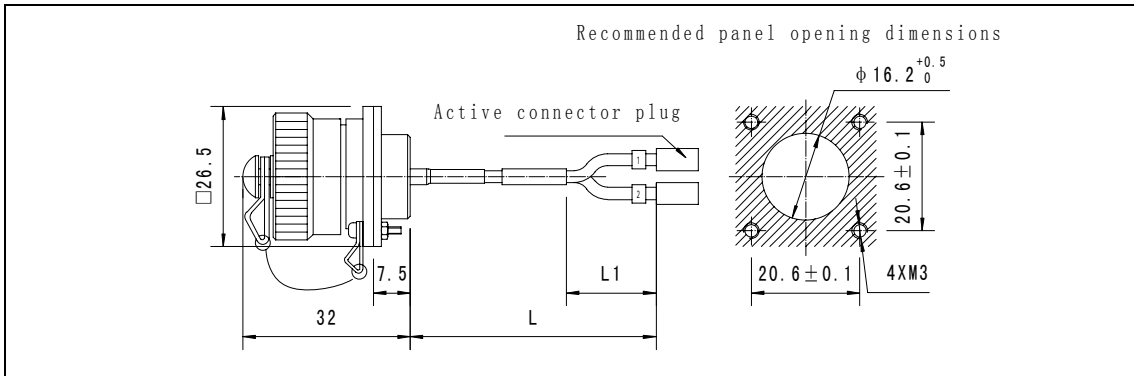

Note: 1) Plug can be anyone in MTRJ, SC, FC, ST, MU and LC;

2) L AND L1 ARE PROVIDED PER USER'S REQUIREMENT.

3) The product mates with PFL16T2SN

[PFL16T2SN01-PFL16T2SN01 2-fiber optic cable connector (used outside the equipment)]

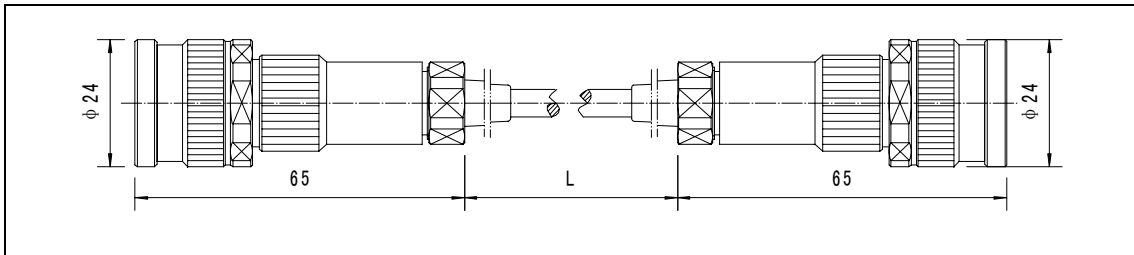

Note: 1) L IS PROVIDED PER USER'S REQUIREMENT.

2) The product mates with PFL16F2PN01.

[PFL16T2SN01 2-fiber optic cable connector (used outside the equipment)]

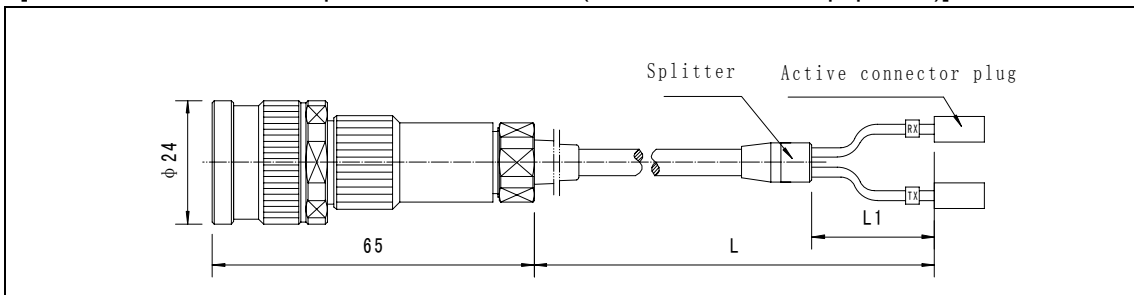

Note: 1) Plug can be anyone in MTRJ, SC, FC, ST, MU and LC;

2) L AND L1 ARE PROVIDED PER USER'S REQUIREMENT.

3) The product mates with PFL16F2PN01.

[PFL16F2PN01 2-fiber optic cable connector (used inside the equipment)]

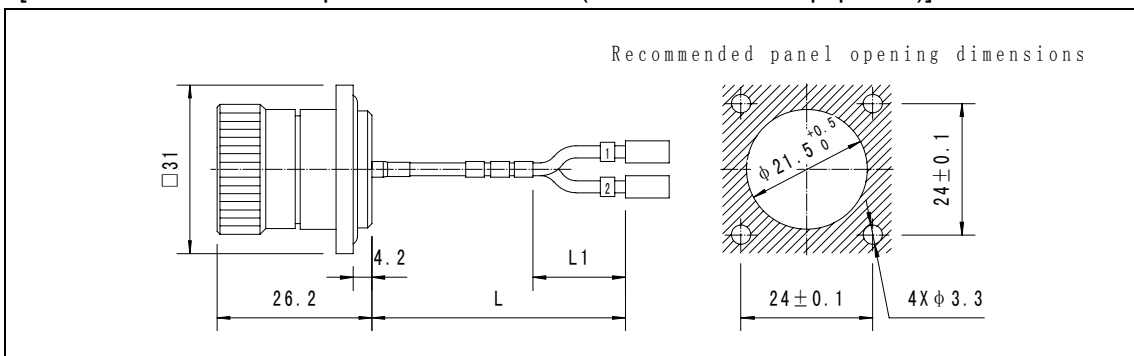

Note: 1) Plug can be anyone in MTRJ, SC, FC, ST, MU and LC;

2) L AND L1 ARE PROVIDED PER USER'S REQUIREMENT.

3) The product mates with PFL16T2SN01

[PFL16F2PN31 2-fiber optic cable connector (used inside the equipment)]

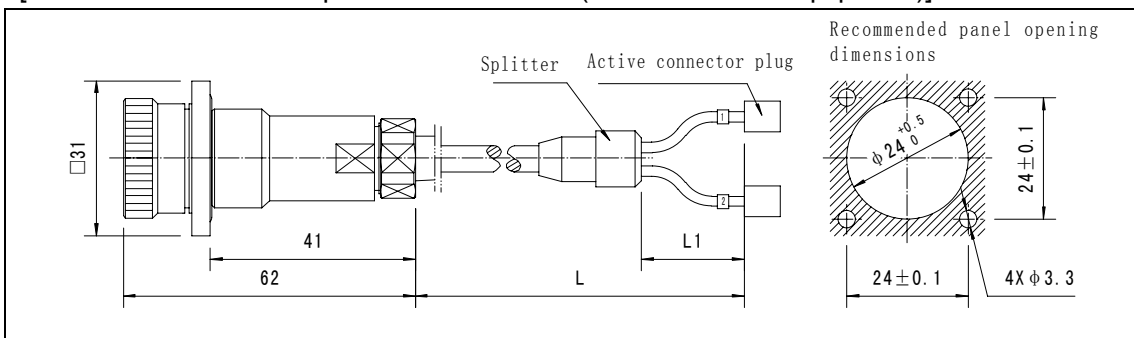

Note: 1) Plug can be anyone in MTRJ, SC, FC, ST, MU and LC;

2) L AND L1 ARE PROVIDED PER USER'S REQUIREMENT.

- 3) The product mates with PFL16T2SN01  
 [PFL16T2SN11-PFL16T2SN11 2-fiber optic cable connector (used outside the equipment)]

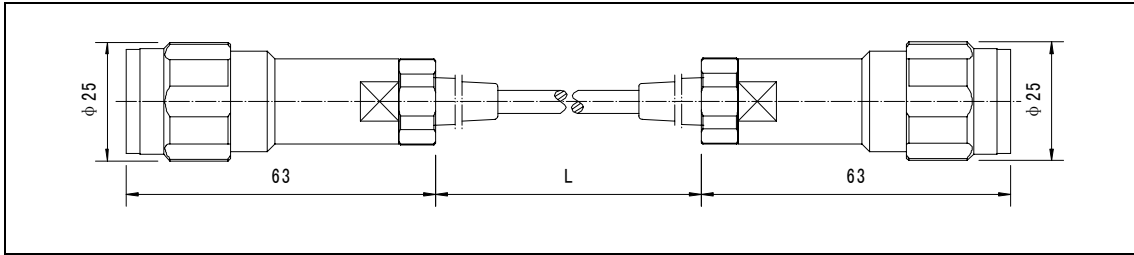

Note: 1) L IS PROVIDED PER USER'S REQUIREMENT.

- 2) The product mates with PFL16F2PN11  
 [PFL16T2SN11 2-fiber optic cable connector (used outside the equipment)]

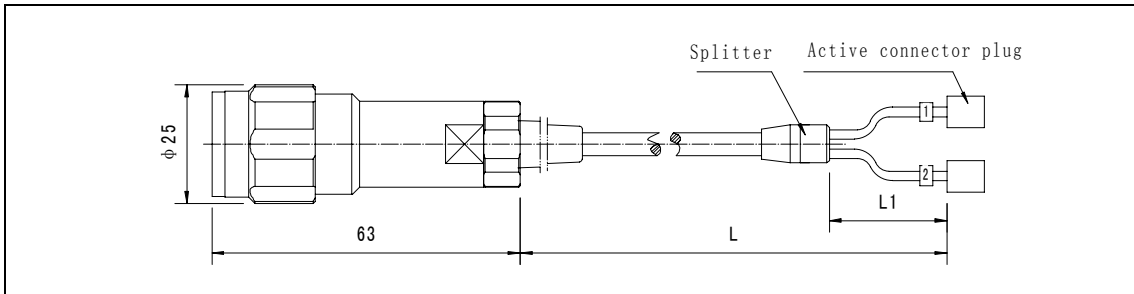

- Note: 1) Plug can be anyone in MTRJ, SC, FC, ST, MU and LC;  
 2) L AND L1 ARE PROVIDED PER USER'S REQUIREMENT.  
 3) The product mates with PFL16F2PN11

[PFL16F2PN11 2-fiber optic cable connector (used inside the equipment)]

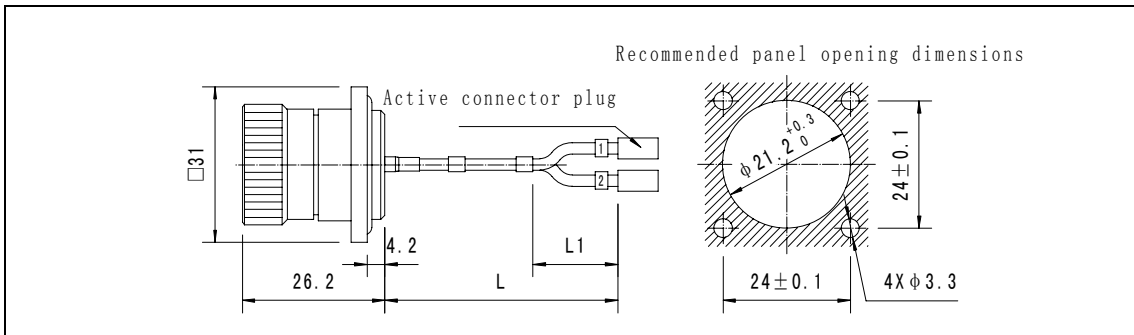

- Note: 1) Plug can be anyone in MTRJ, SC, FC, ST, MU and LC;  
 2) L AND L1 ARE PROVIDED PER USER'S REQUIREMENT.  
 3) The product mates with PFL16T2SN11