

6GHz~18GHz

Typical test curve

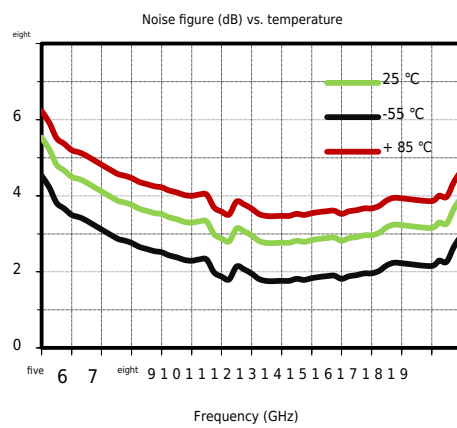
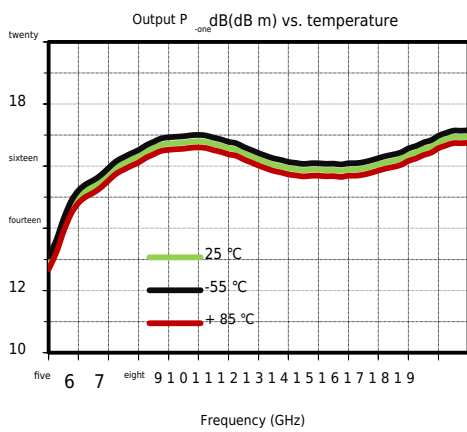
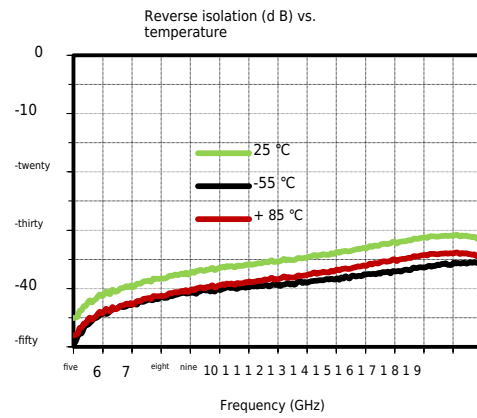
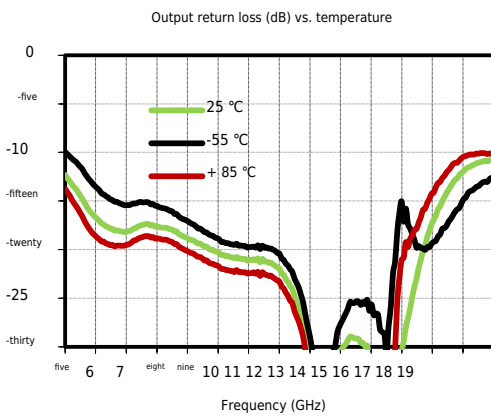
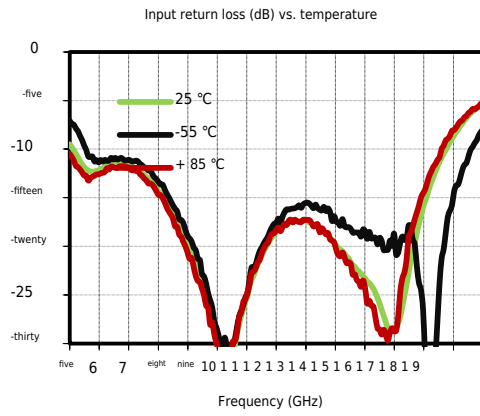
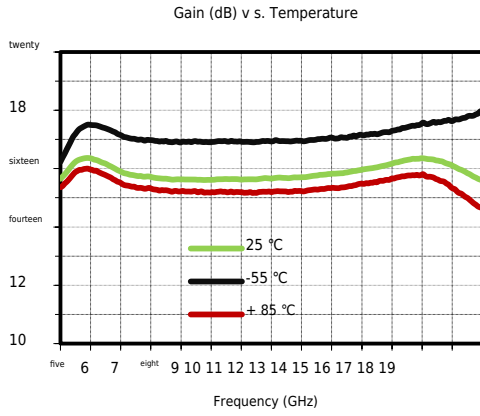

GaAs monolithic integrated driver amplifier
6GHz~18GHz

Shape and port size (mm)

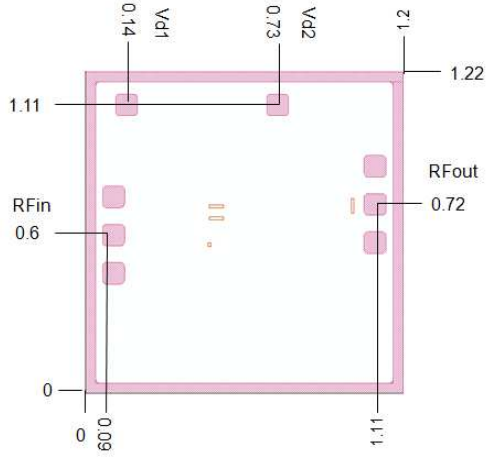

Recommended assembly drawing

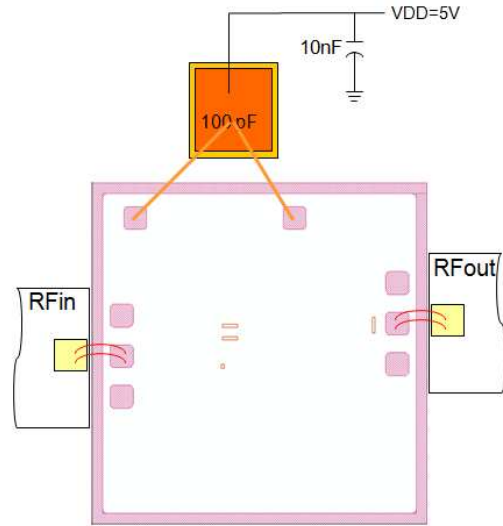

Precautions

Gallium arsenide MMIC devices are susceptible to damage from electrostatic discharge. Precautions should be taken during transportation, assembly and testing.